



Chevy Sonic Flex Fuel Kit

Install time: 30 minutes to 1 hour

In the Box:

- (1) Flex fuel sensor
- (2) QD AN fittings
- (1) 90 degree union
- (1) Wire harness
- (1) Fuse tap holder and fuse

Instructions:

1. Start by removing the ECM gray connector harness. Lift upwards on the black tab after releasing the red lock. Then gently remove the harness from the ECM. (Fig 1 & 2)
2. Remove the black casing around the connector to access the wiring. The face of the harness (gray retaining plate) will also be removed. Do this by gently prying on either side of the plate. (Fig 3)
3. Locate pin 20 and 34, and using a small flat head screwdriver press the gray pins out of the connector. You will then pull the black ground wire through pin 20 and the white signal wire through pin 34. Make sure the connector is seated correctly in the terminal. With pins seated, re-assemble the connector and route wiring. (Fig 4)
4. Next we will remove the fuse box cover on the driver side. Locate the row of 10 amp fuses and 1 unused slot. We will use this slot for the +12v switched ignition source. (Fig 5)
5. Route supplied fuse and crimp +12v wire to flex fuel sensor. Re-install fuse box cover. Be sure to route the wire correctly or it will get pinched. (Fig 6)
6. Remove the OEM fuel hose using a quick release wrench. Then you will install the 6AN quick connect fitting followed by the 90 degree union and the second 6AN quick connect fitting. Connect the OEM fuel line to the other side of the flex fuel sensor. Do not use excessive force while tightening AN fittings, the fitting seals on the conical face. (Fig 7)
7. Finally, route the black, white and red wires to the flex fuel sensor. Crimp them to their respective colors and plug in the connector. Then key the ignition on, but do not start the vehicle. Check for fuel leaks where the new sensor was installed. If no fuel leaks are found, start the vehicle and once again check for leaks. Installation complete.

Questions, comments, or concerns? Email tech@racerxfabrication.com.

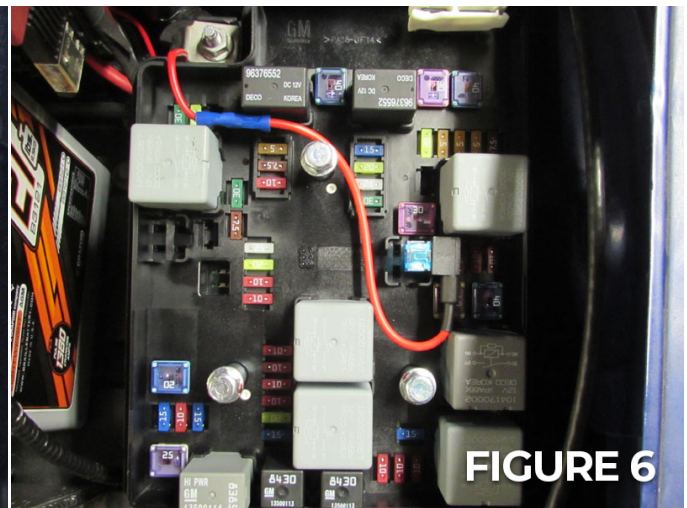
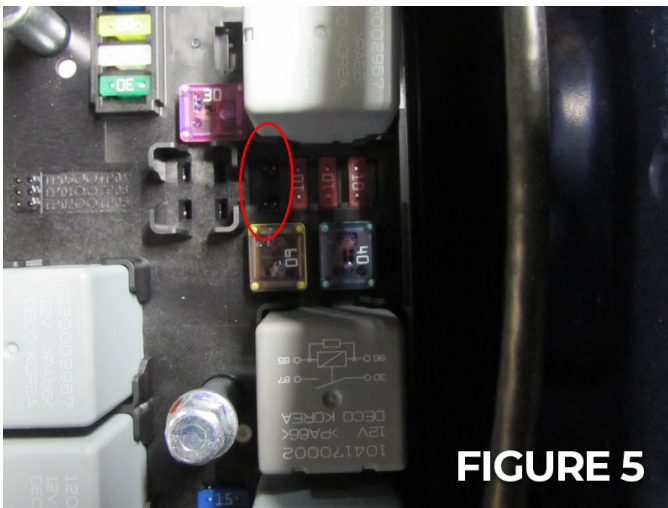
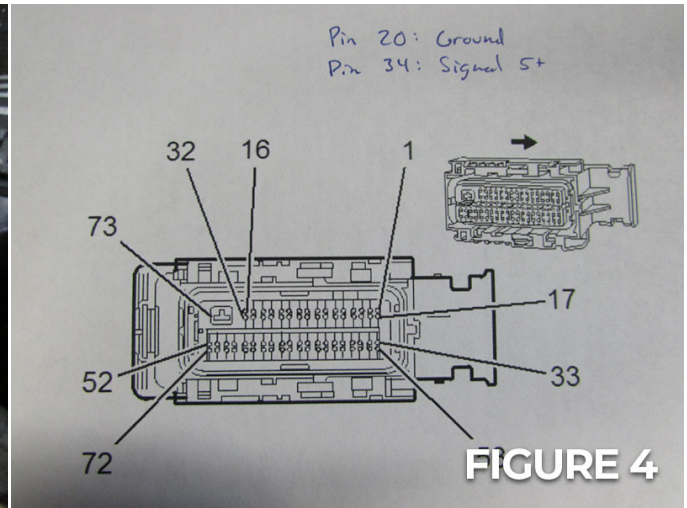
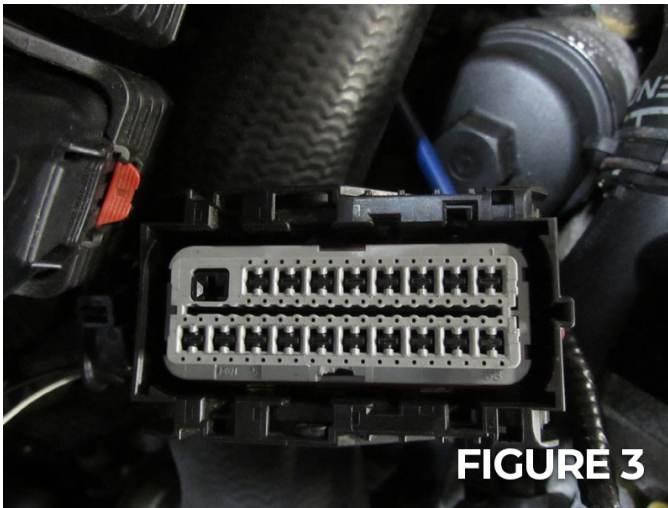
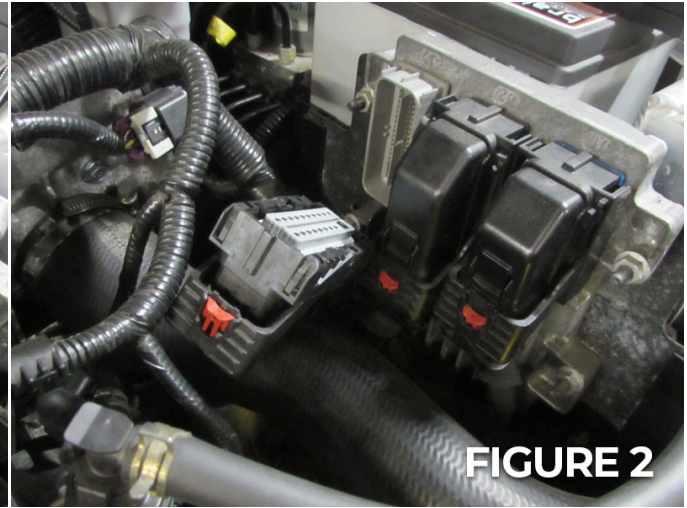
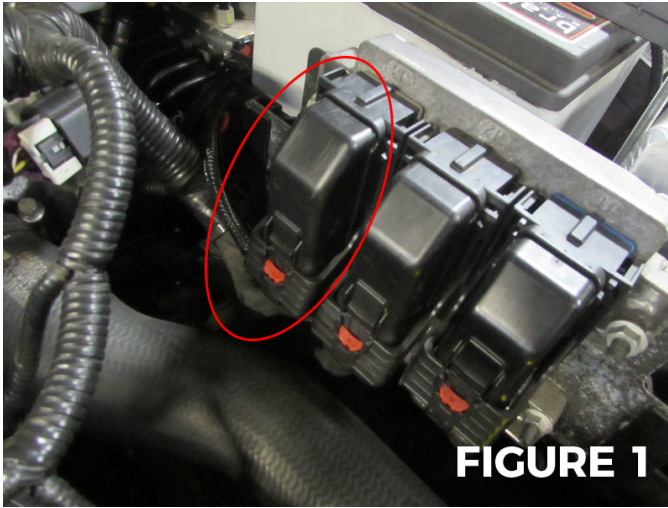

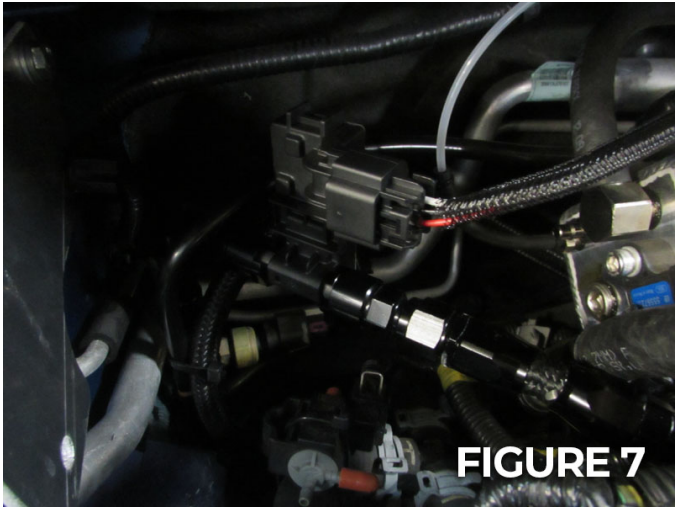

FIGURE 7